



Cup Sealer
Model SE-CN-0095
Item 44644
Instruction Manual



Revised - 03/22/2023



Toll Free: 1-800-465-0234
Fax: 905-607-0234
Email: service@omcan.com
www.omcan.com



Table of Contents

Model SE-CN-0095

Section	Page
General Information -----	3 - 4
Safety and Warranty -----	4 - 5
Technical Specifications -----	5
Installation -----	6
Operation -----	7 - 8
Maintenance -----	8
Troubleshooting -----	9 - 11
Parts Breakdown -----	12 - 14
Electrical Schematics -----	15
Notes -----	16 - 18
Warranty Registration -----	19



General Information

Omcan Manufacturing and Distributing Company Inc., Food Machinery of America, Inc. dba Omcan and Omcan Inc. are not responsible for any harm or injury caused due to any person's improper or negligent use of this equipment. The product shall only be operated by someone over the age of 18, of sound mind, and not under the influence of any drugs or alcohol, who has been trained in the correct operation of this machine, and is wearing authorized, proper safety clothing. Any modification to the machine voids any warranty, and may cause harm to individuals using the machine or in the vicinity of the machine while in operation.

CHECK PACKAGE UPON ARRIVAL

Upon receipt of an Omcan shipment please inspect for external damage. If no damage is evident on the external packaging, open carton to ensure all ordered items are within the box, and there is no concealed damage to the machine. If the package has suffered rough handling, bumps or damage (visible or concealed), please note it on the bill of lading before accepting the delivery and contact Omcan within 24 hours, so we may initiate a claim with the carrier. A detailed report on the extent of the damage caused to the machine must be filled out within three days, from the delivery date shown in the shipping documents. Omcan has no recourse for damaged products that were shipped collect or third party.

Before operating any equipment, always read and familiarize yourself with all operation and safety instructions.

Omcan would like to thank you for purchasing this machine. It's of the utmost importance to save these instructions for future reference. Also save the original box and packaging for shipping the equipment if servicing or returning of the machine is required.

Omcan Fabrication et distribution Compañie Limité et Food Machinery d'Amérique, dba Omcan et Omcan Inc. ne sont pas responsables de tout dommage ou blessure causé du fait que toute personne ait utilisé cet équipement de façon irrégulière. Le produit ne doit être exploité que par quelqu'un de plus de 18 ans, saine d'esprit, et pas sous l'influence d'une drogue ou d'alcool, qui a été formé pour utiliser cette machine correctement, et est vêtu de vêtements de sécurité approprié. Toute modification de la machine annule toute garantie, et peut causer un préjudice à des personnes utilisant la machine ou des personnes à proximité de la machine pendant son fonctionnement.

VÉRIFIEZ LE COLIS DÈS RÉCEPTION

Dès réception d'une expédition d'Omcan veuillez inspecter pour dommages externes. Si aucun dommage n'est visible sur l'emballage externe, ouvrez le carton afin de s'assurer que tous les éléments commandés sont dans la boîte, et il n'y a aucun dommage dissimulé à la machine. Si le colis n'a subi aucune mauvaises manipulations, de bosses ou de dommages (visible ou cachée), notez-le sur le bond de livraison avant d'accepter la livraison et contactez Omcan dans les 24 heures qui suivent, pour que nous puissions engager une réclamation auprès du transporteur. Un rapport détaillé sur l'étendue des dommages causés à la machine doit être rempli dans un délai de trois jours, à compter de la date de livraison indiquée dans les documents d'expédition. Omcan n'a aucun droit de recours pour les produits endommagés qui ont été expédiés ou cueilli par un tiers transporteur.

General Information

Avant d'utiliser n'importe quel équipement, toujours lire et vous familiariser avec toutes les opérations et les consignes de sécurité.

Omcan voudrais vous remercier d'avoir choisi cette machine. Il est primordial de conserver ces instructions pour une référence ultérieure. Également conservez la boîte originale et l'emballage pour l'expédition de l'équipement si l'entretien ou le retour de la machine est nécessaire.

Omcan Empresa De Fabricacion Y Distribucion Inc. Y Maquinaria De Alimentos De America, Inc. dba Omcan y Omcan Inc. no son responsables de ningun daño o perjuicio causado por cualquier persona inadecuada o el uso descuidado de este equipo. El producto solo podra ser operado por una persona mayor de 18 años, en su sano juicio y no bajo alguna influencia de droga o alcohol, y que este ha sido entrenado en el correcto funcionamiento de esta máquina, y ésta usando ropa apropiada y autorizada. Cualquier modificación a la máquina anula la garantía y puede causar daños a las personas usando la máquina mientras esta en el funcionamiento.

REVISE EL PAQUETE A SU LLEGADA

Tras la recepcion de un envio Omcan favor inspeccionar daños externos. Si no hay daños evidentes en el empaque exterior, Habra el carton para asegurarse que todos los articulos solicitados estén dentro de la caja y no encuentre daños ocultos en la máquina. Si el paquete ha sufrido un manejo de poco cuidado, golpes o daños (visible o oculto) por favor anote en la factura antes de aceptar la entrega y contacte Omcan dentro de las 24 horas, de modo que podamos iniciar una reclamación con la compañía. Un informe detallado sobre los daños causados a la máquina debe ser llenado en el plazo de tres días, desde la fecha de entrega que se muestra en los documentos de envío. Omcan no tiene ningun recurso por productos dañados que se enviaron a recoger por terceros.

Antes de utilizar cualquier equipo, siempre lea y familiarizarse con todas las instrucciones de funcionamiento y seguridad.

Omcan le gustaría darle las gracias por la compra de esta máquina. Es de la mayor importancia para salvar estas instrucciones para futuras consultas. Además, guarda la caja original y el embalaje para el envío del equipo si servicio técnico o devolución de la máquina que se requiere.

Safety and Warranty

RESIDENTIAL USERS: Vendor assumes no liability for parts or labor coverage for component failure or other damages resulting from installation in non-commercial or residential applications. The right is reserved to deny shipment for residential usage; if this occurs, you will be notified as soon as possible.

1 YEAR PART AND LABOUR BENCH WARRANTY



Safety and Warranty

Within the warranty period, contact Omcan Inc. at 1-800-465-0234 to schedule a drop off to either an Omcan authorized service depot in the area, or to an Omcan Service warehouse to repair the equipment.

Unauthorized maintenance will void the warranty. Warranty covers electrical and part failures, not improper use.

Please see <https://omcan.com/disclaimer> for complete info.

WARNING:

The packaging components (cardboard, polyethylene, and others) are classified as normal solid urban waste and can therefore be disposed of without difficulty.

In any case, for suitable recycling, we suggest disposing of the products separately (differentiated waste) according to the current norms.

DO NOT DISCARD ANY PACKAGING MATERIALS IN THE ENVIRONMENT!

Technical Specifications

Model	SE-CN-0095
Power	120 W
Electrical	110-120V / 60Hz / 1
Cup Size	3.7" / 95mm
Weight	55.1 lbs. / 25 kgs.
Packaging Weight	59.5 lbs. / 27 kgs.
Dimensions	12.8" x 13.8" x 23.3" / 325 x 351 x 592mm
Packaging Dimensions	19.9" x 14.8" x 27" / 505 x 376 x 686mm
Item Number	44644

Installation

Please follow the below procedure:

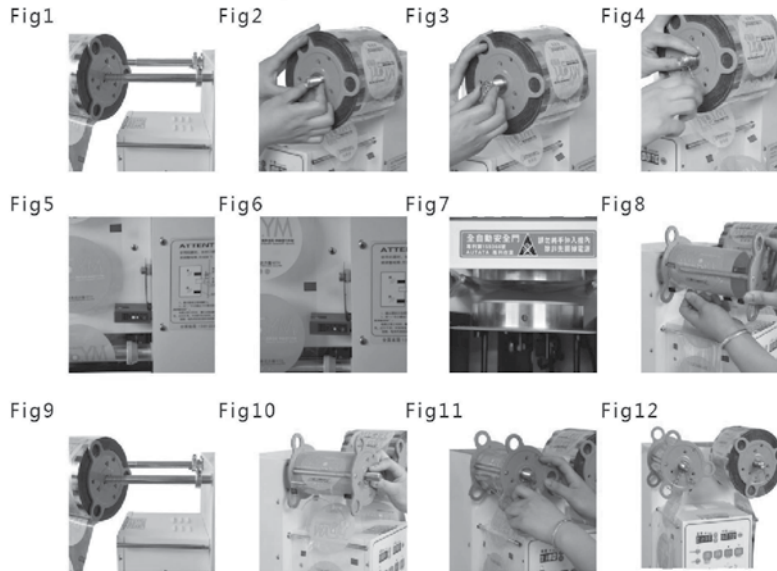

Please note the relative positions between the membrane and all the 6 guide pins.

To make sure the rotation of the membrane is driven by the roller, the slot on the pressing board should hold the screw of the active position ring.

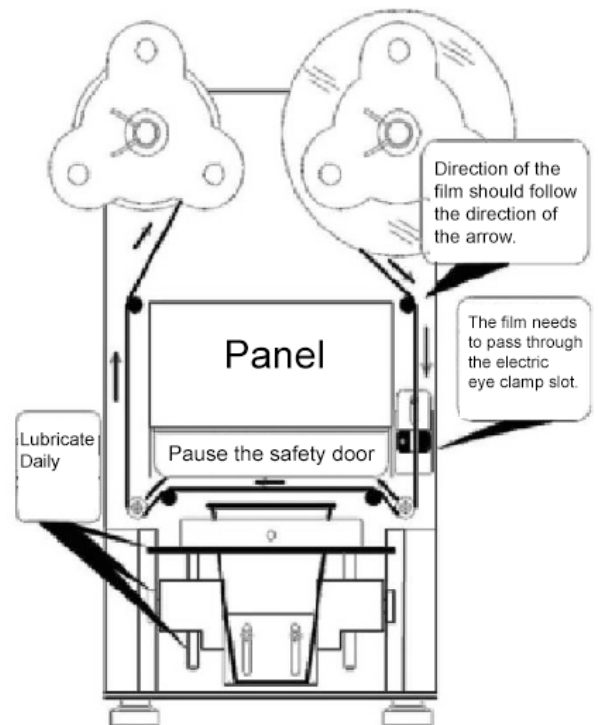

The machine is to be powered with by 110V AC with a grounded wire. When the power light flashes it means that the machine is powered and in standby mode.

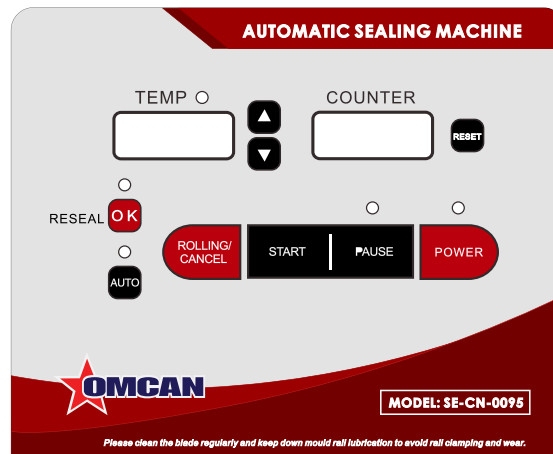

Press the power button, the power light turns on.

Press the pause button, all operation is paused and held. To continued the paused operation, press the start button.

To cancel, press the rolling/cancel button. You can also cancel paused operations.

When the current state is in standby, the waste membrane roller will rotate continuously.

Auto button: when the button is held, the machine will switch between auto mode and half auto mode. When the auto light is on, it is in auto mode. When the light is off, it is in half auto mode. If the button is not held down, the machine will be in smart auxiliary function mode.

Reset button: press this button and the machine will be in counter hidden mode. Press this button again to go back into counter mode. Hold down this button until you hear a beep, the current counter will be cleared.

SMART AUXILIARY FUNCTIONS

LEAKAGE PREVENTING FUNCTION

In standby mode, press the auto button, the auto single light flashes, that means the machine has entered the smart auxiliary functions. After placing a container that isn't sealing properly, press the start button. The machine will start leakage preventing operations with the required parameters. Remove the container and the machine will enter the standby state again.

AUTO CUTTER WASHING FUNCTION

In the standby state, install the drain plug into the outlet and use a napkin or other similar materials to seal the outlet tightly. Put some warm water in the sink. Press and hold the pause button until it beeps, the machine will enter auto cutter washing mode. The platform will slide out when the washing is finished. Press the cancel button to return to the standby state.

Operation

CUSTOM PARAMETER SETTING

The sealing time, giving in time and giving out time can be user defined. There is an option for using or not using the electrical eye, which is useful for the polished membrane, aluminum membrane, ect.

Parameters	Code	Meaning
Sealing Time	H	H (02~22): 0.2~2.2s
Giving In Time	C	C (00~10): 0~1s
Giving Out Time	F	F00: using electrical eye. F (01~20): blank membrane.

MATERIALS

Compatible Material	Temperature
PE Cup	175°C / 175°C
PP Cup	170 - 180°C / 170 - 180°C
PET Cup	185 - 195°C / 185 - 195°C
Paper Cup	175°C / 175°C
PLA Biodegradable Cup	120 - 150°C / 120 - 150°C

Maintenance

The following procedures should be completed every day:

1. Make sure the heating disc is clear.
Attention: If you want to clean the disc with a damp cloth, the unit must be disconnected from the power supply and cooled completely.
2. Make sure the platform is clear, and ensure the guide rails are well lubricated.
Note: it is advised to refill the rail of the machine once a week. Only use food safe oil with this machine.
3. Make sure the sink is clear.
4. Make sure the electrical eye and the micro switch is clear.
5. Make sure the membrane cutter is clear by using the auto cutter washing function.

Troubleshooting

Problem	Possible Cause	Solution
The graphic pattern skips before the machine seals.	The membrane is not in the electrical eye gap.	Place the membrane in the gap.
	The electrical eye is dirty.	Clean it.
	The sensitivity of the electrical eye is mismatched.	Adjust it according to the instructions on the machine.
The cup is squashed.	The height of the cup tray is set at the default for 500cc cups.	Adjust the cup height.
The membrane logo is not centered during sealing.	The electrical eye is misaligned.	Adjust the electrical eye.
	The positioning ring is misaligned.	Adjust the positioning ring.
One side of the cup is not sealing well.	There is dirt on the heating plate.	Once cooled, wipe it with a damp towel (do not use a knife to scrape).
	The spring inside the heating plate is broken.	Replace the heating plate kit.
	Defective cup.	If other cups can be sealed, change the cup.
The machine does not run automatically, you need to press the start button continuously.	Check whether the automatic light on the panel is in the steady state. If it is not lit, the automatic function is turned off.	Press and hold the automatic button for three seconds to turn on the automatic function.
	The root of the long tail trigger switch is stained with oil or milk tea, so that the wire cannot be lifted.	Wipe it with a wet towel.
	Open the rear cover and check if the long tail trigger switch cable is loose or damaged.	Re-plug the trigger switch or replace if damaged.
The film winding motor rotates weakly or does not work?	The roll of the film roll is weak.	Check if the innermost fixing screw of the pole is loose. If it is loose, tighten the screw.
		Press and hold the film button. If the film motor does not turn, the film motor is damaged and needs to be replaced.
	The film winding motor is reversed, or the film winding motor is damaged (capacitor failure).	The film winding motor needs to be replaced.
	The film motor rotates all the time.	Replace the motherboard.

Troubleshooting

Error Code: E51.	The sensitivity of the electronic eye is high. The transparent part of the sealing film is placed in the groove of the electronic eye.	When the red light is on, turn the adjusting screw on the right side of the electronic eye clockwise until the red light is off (do not turn more). If it is invalid, the electronic eye is damaged and the electronic eye needs to be replaced.
Error Code: E52.	The film has not passed through the groove of the electronic eye.	Put the film into the groove.
	The sensitivity of the electronic eye is low, the black cursor is placed in the electronic eye groove, the red light is not bright.	Turn the right eye adjustment screw of the electronic eye clockwise until the red light is on (do not turn more). If it is invalid, the electronic eye is damaged and the electronic eye needs to be replaced.
Error Code: E1/E2.	The flange is worn.	Replace the flange set.
	The upper and lower switches are damaged.	Replace the upper and lower switches.
	The upper and lower motor levers are deformed or broken.	Replace the main board and the lever.
	The motor is turned to half, it will not be able to rotate, and an abnormal noise will be emitted.	The upper and lower motors need to be replaced.
	The voltage is unstable.	Install a voltage regulator (220V-300W).
Error Code: E3/E4.	The rail is short of oil.	Refuel the rail beam.
	The in-and-out switch is damaged, or there is no elasticity.	Replace the in-and-out switch.
	The corresponding switch light on the main board is on. If it is bright, but the alarm prompts, the main board is damaged.	Replace the main board.
	The motor is turned to half, it will not be able to rotate, and an abnormal noise will be emitted.	The upper and lower motors need to be replaced.
Error Code: E43.	The out-of-position switch is damaged.	The out-of-position switch needs to be replaced.
	The carry switch is damaged.	The carry switch needs to be replaced.

Troubleshooting

Error Code: 8888.	The cable is loose.	Re-insert the cable.
	The cable is damaged.	Replace the cable.
	The panel is damaged.	Replace the panel.
Error Code: 1023.	The thermocouple is loose at the motherboard.	Reconnect the thermocouple.
	The thermocouple is damaged.	The hot plate kit needs to be replaced.

ADDITIONAL INCORRECT OPERATIONS

- The spring of the driven stick is not installed correctly or compressed tightly.



- The membrane is not installed in the U-type slot of the electrical eye.



- The tracking symbol (a square box) on the membrane is not on the light path of the electrical eye.
- The membrane is not through the right side of the giving in stick.



- The positioning ring of the left side roller is changed.
- The clamping board slot does not match the screw of the driving stick positioning ring.

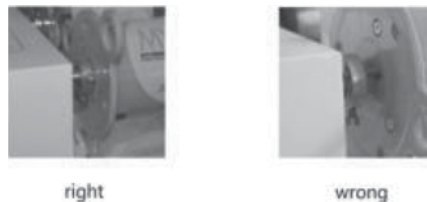

Parts Breakdown

Model SE-CN-0095 44644



1



2



3



4

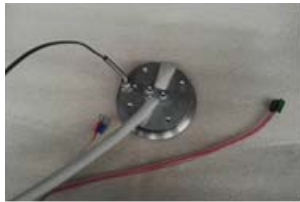

5



6



7



8



9



10



11



12



13



14



15



16



17



18



19



20

Parts Breakdown

Model SE-CN-0095 44644



21

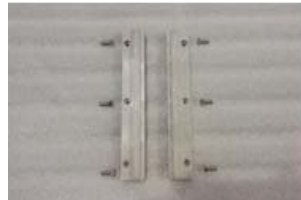

22



23



24



25



26



27



28



29



30



31

Parts Breakdown

Model SE-CN-0095 44644

Item No.	Description	Position	Item No.	Description	Position	Item No.	Description	Position
AG497	Main PCB (Big PCB) for 44644	1	AG508	Input and Output Switch for 44644	12	AG519	Upper Mold for 44644	23
AG498	PCB Displayer (Panel PCB) for 44644	2	AG509	Up and Down Switch for 44644	13	AG520	Lower Mold for 44644	24
AG499	Control Shell without Main PCB for 44644	3	AG510	Film Rolling Bucket-Baffle for 44644	14	AG521	Cable for 44644	25
AG500	Alloy Cutter for 44644	4	AG511	Grommet-Ring for 44644	15	AG522	Power Line for 44644	26
AG501	Heating Kit (Anti-Stick with Built In Spring Screw Set) for 44644	5	AG512	Beam for 44644	16	AG523	Positioning Ring (2pc Set) for 44644	27
AG502	Upper and Lower Motor for 44644	6	AG513	Cup Holder for 44644	17	AG524	Heating Rod for 44644	28
AG503	Output and Input Motor for 44644	7	AG514	High Foot (4pc Set) for 44644	18	AG525	Thermocouple for 44644	29
AG504	Film Rolling Motor for 44644	8	AG515	Capacitor for 44644	19	AG526	Hole Punch for 44644	30
AG505	Electronic Eye Assembly for 44644	9	AG516	Flange (2pc Set) for 44644	20	AG527	Start Switch for 44644	31
AG506	Sensory Switch for 44644	10	AG517	Layer or Covering for 44644	21			
AG507	Inner and Outer Springs-Screws for 44644	11	AG518	Rail Plate (2pc Set) for 44644	22			

Electrical Schematics

Model SE-CN-0095 44644

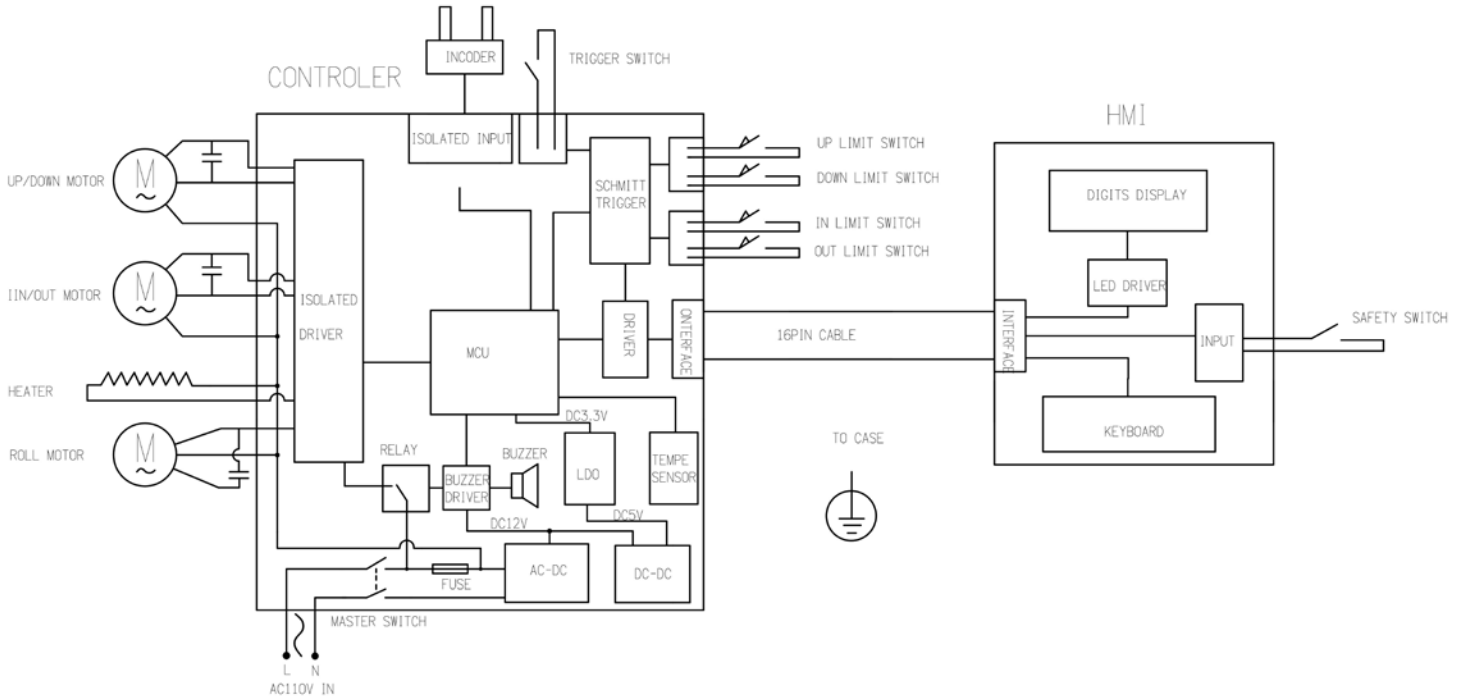

NEMA
5 - 15P
125VAC / 15 AMP



Warranty Registration

Thank you for purchasing an Omcan product. To register your warranty for this product, complete the information below, tear off the card at the perforation and then send to the address specified below. You can also register online by visiting:

Merci d'avoir acheté un produit Omcan. Pour enregistrer votre garantie pour ce produit, complétez les informations ci-dessous, détachez la carte au niveau de la perforation, puis l'envoyer à l'adresse spécifiée ci-dessous. Vous pouvez également vous inscrire en ligne en visitant:

Gracias por comprar un producto Omcan usted. Para registrar su garantía para este producto, complete la información a continuación, cortar la tarjeta en la perforación y luego enviarlo a la dirección indicada a continuación. También puede registrarse en línea en:

<https://omcan.com/warranty-registration/>

For mailing in Canada

Pour postale au Canada

Por correo en Canadá

OMCAN

PRODUCT WARRANTY REGISTRATION

3115 Pepper Mill Court,

Mississauga, Ontario

Canada, L5L 4X5

For mailing in the US

Pour diffusion aux États-Unis

Por correo en los EE.UU.

OMCAN

PRODUCT WARRANTY REGISTRATION

4450 Witmer Industrial Estates, Unit 4,

Niagara Falls, New York

USA, 14305

or email to: service@omcan.com



Purchaser's Information

Name: _____

Address: _____

City: _____ Province or State: _____ Postal or Zip: _____

Country: _____

Dealer from which Purchased: _____

Dealer City: _____ Dealer Province or State: _____

Invoice: _____

Model Name: _____ Model Number: _____

Machine Description: _____

Date of Purchase (MM/DD/YYYY): _____

Would you like to extend the warranty? Yes No

Company Name: _____

Telephone: _____

Email Address: _____

Type of Company:

Restaurant Bakery Deli

Butcher Supermarket Caterer

Institution (*specify*): _____

Other (*specify*): _____

Serial Number: _____

Date of Installation (MM/DD/YYYY): _____

Thank you for choosing Omcan | Merci d'avoir choisi Omcan | Gracias por elegir Omcan



Since 1951 Omcan has grown to become a leading distributor of equipment and supplies to the North American food service industry. Our success over these many years can be attributed to our commitment to strengthen and develop new and existing relationships with our valued customers and manufacturers. Today with partners in North America, Europe, Asia and South America, we continually work to improve and grow the company. We strive to offer customers exceptional value through our qualified local sales and service representatives who provide convenient access to over 6,500 globally sourced products.

Depuis 1951 Omcan a grandi pour devenir un des “leaders” de la distribution des équipements et matériel pour l’industrie des services alimentaires en Amérique du Nord. Notre succès au cours de ces nombreuses années peut être attribué à notre engagement à renforcer et à développer de nouvelles et existantes relations avec nos clients et les fabricants de valeur. Aujourd’hui avec des partenaires en Amérique du Nord, Europe, Asie et Amérique du Sud, nous travaillons continuellement à améliorer et développer l’entreprise. Nous nous efforçons d’offrir à nos clients une valeur exceptionnelle grâce à nos ventes locales qualifiées et des représentants de service qui offrent un accès facile à plus de 6500 produits provenant du monde entier.

Desde 1951 Omcan ha crecido hasta convertirse en un líder en la distribución de equipos y suministros de alimentos en América del Norte industria de servicios. Nuestro éxito en estos años se puede atribuir a nuestro compromiso de fortalecer y desarrollar nuevas relaciones existentes con nuestros valiosos clientes y fabricantes. Hoy con socios de América del Norte, Europa, Asia y América del Sur, que trabajan continuamente para mejorar y crecer la empresa. Nos esforzamos por ofrecer a nuestros clientes valor excepcional a través de nuestro local de ventas y representantes de los servicios que proporcionan un fácil acceso a más de 6,500 productos con origen a nivel mundial.

